

## PLEASE REGISTER YOUR NEW PRODUCT

To register your product online please go to:

[www.ropeflex.com/warranty-and-registration](http://www.ropeflex.com/warranty-and-registration)

Product serial number is located on equipment or is shown in the box below

SERIAL NUMBER

If serial number is not shown  
please check equipment

# ROPEFLEX®

ORYX – RX2100 OX2 & OX20

Assembly Instructions & Manual

DOC: 32-1015

Configuration subject to change

## WARNING DECAL PLACEMENT

---

The decals shown here have been placed on the equipment in indicated locations. If any of the decals are missing or illegible, call us toll-free at 650.549.5888, Monday through Friday, 9 a.m. until 5 p.m. Pacific Time, to order replacement decals. Apply replacement decals in the locations shown.



## IMPORTANT PRECAUTIONS

---

 **WARNING:** To reduce the risk of serious injury, read the following important precautions before using this equipment.

1. Read all instructions in this manual and assemble as described before using this equipment.
2. It is the responsibility of the owner to ensure that all users of this equipment are adequately informed of all precautions.
3. Use this equipment only on a level surface.  
Cover the floor beneath to protect the surface.
4. Keep children under 12 and pets away from the equipment at all times.
5. Make sure all parts are properly tightened each time you use this machine. Replace any worn parts immediately.
6. Make sure the adjustment knobs are fully engaged / disengaged before using the equipment.
7. Always wear athletic shoes for foot protection while exercising.
8. This equipment is designed to support a maximum user weight of 300 pounds.
9. Pull on one the rope only and never grab a rope in a way that prevents the drum from rotating. Never attempt to hang on the rope or frame. Pull rope with hands only.
10. If you feel pain or dizziness at any time while exercising, stop immediately and begin cooling down.

 **WARNING:** Before beginning this or any exercise program, consult your physician. This is especially important for persons over the age of 35 or persons with pre-existing health problems. Read all instructions before using. ROPEFLEX assumes no responsibility for personal injury or property damage sustained by or through the use of this product.

## Box Contents / Parts List

---

### MAIN DRUM ASSEMBLY

ITEM	QUANTITY	DESCRIPTION
1	1	OXII Drum with Rope
2	1	OXII Bracket Plate
3	4	Hex Bolt 1/2-13" x 5.5"
4	8	Washer 1/2"
5	4	Hex Lock Nut 1/2-13"

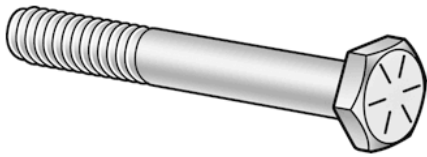

**Qty.4**

**Hex Bolt 1/2-13" x 5.5"**



**Qty.8**

**Washer 1/2"**



**Qty.4**

**Lock-nut 1/2-13"**

## Tools Required for Assembly

---

3/4 Hex Socket Ratchet Wrench

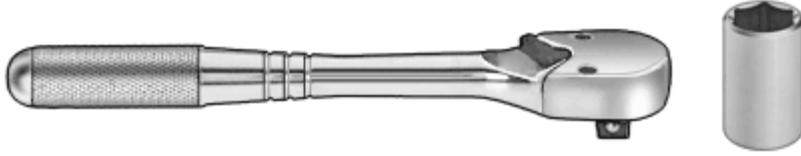

3/4 Hex Open Wrench

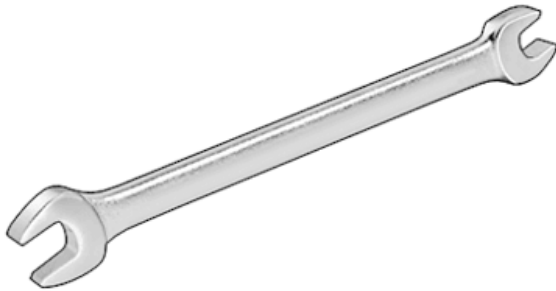

## Product Installation

---

### STEP 1

1-1 With 2 bolts installed as shown adjust the distance between bracket plates as close to the beam width as possible while allowing the unit to be mounted.

1-2 If necessary use additional  $\frac{1}{2}$ " steel washers (not provided) to insure that once the bolt is tightened it does not touch the rope or drum.

1-3 Tighten all hardware.



**Note:** Do not attempt assembly alone. 2 person installation required. Never hang on the unit or the rope. This will void the warranty and may result in injury or death.

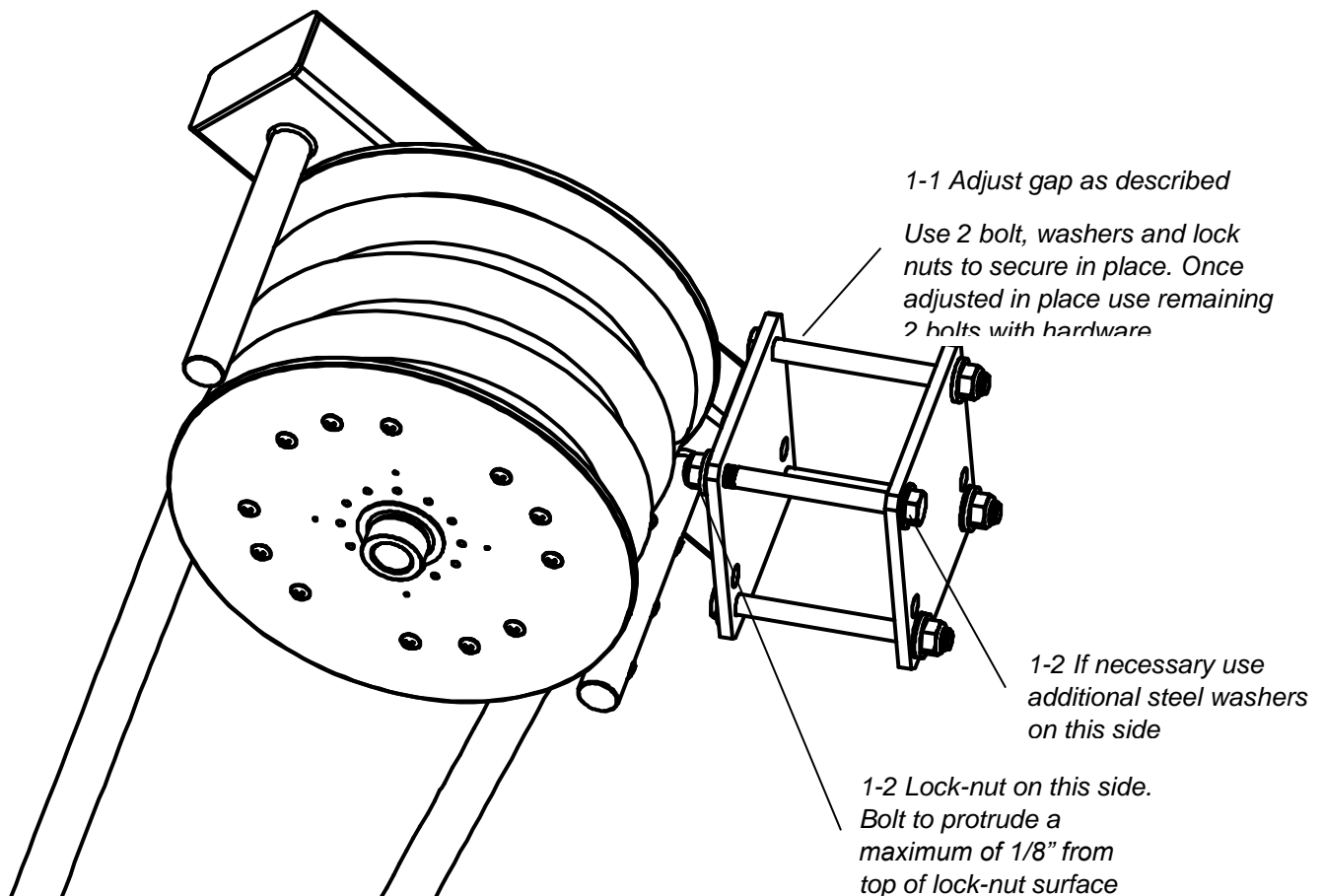

# Bracket installation hole pattern

---

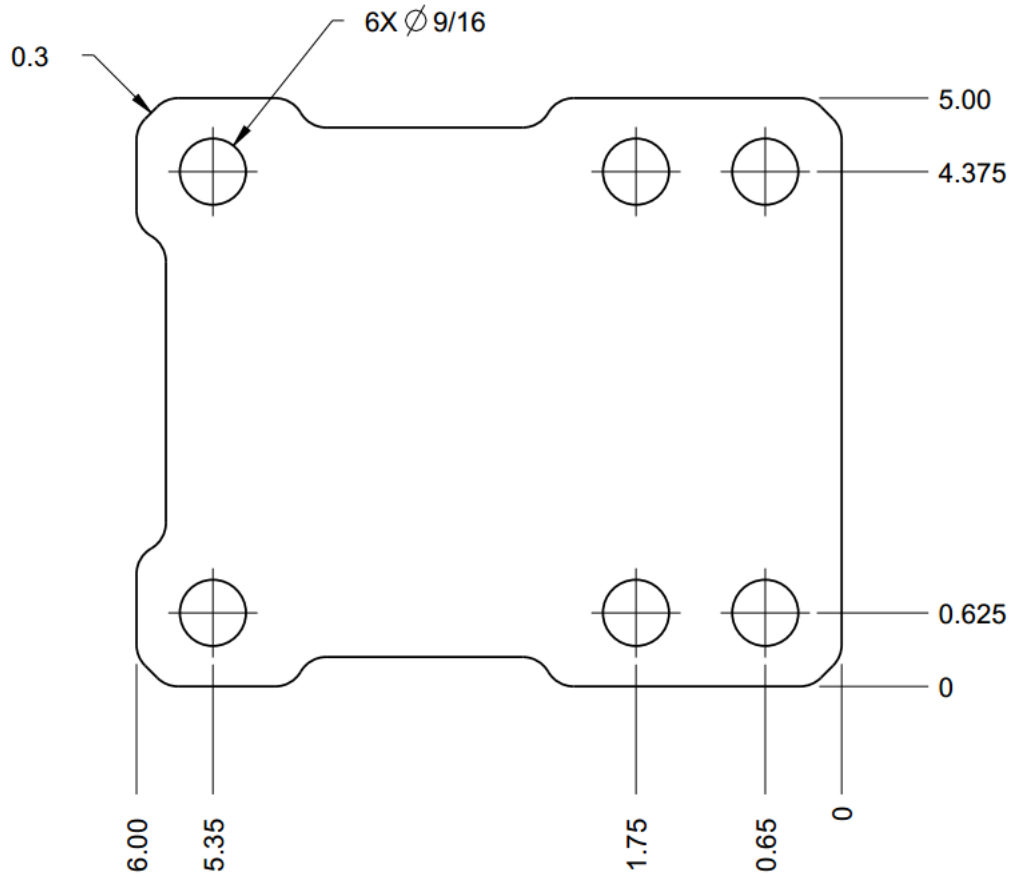

## Sample Configuration 1: Indoor

---





## Sample Configuration 2: Outdoor

---



## Equipment Maintenance

---

**WARNING:** Routine inspection and maintenance is of critical importance to ensure maximum safety and performance. We use the highest quality materials available, but wear is inevitable. Be advised that dangerous conditions can arise even during a warranty period. A warranty does not negate the owner's responsibility to thoroughly, carefully and daily inspect the machine. Consult your physician before starting your exercise program. For your own safety, do not begin any exercise program without proper instruction.

### 1. Check Rope

While the machine is not in use carefully inspect the rope for damage and tears. Carefully inspect connection of rope ends and make sure that stitching (threads) are not torn or damaged. Do not use equipment until damaged rope has been replaced.

### 2. Upholstery

Wipe down after every workout.

Periodically take the time to use a mild soap or mild vinyl upholstery cleaner. Avoid using any abrasive cleaner not intended for use on vinyl.

Keep sharp or pointed objects out of your pockets and clear of all upholstery.

### 3. Nuts/Bolts/Fasteners

Periodically inspect all nuts and bolts. Tighten if needed. If bolts seem to loosen periodically, use Loctite 242 for a long-term cure.

Go through a re-tightening sequence periodically to ensure that all hardware is properly tensioned.

### 4. Adjustments / Locking Pins / Tightening Knobs

Check all pieces for signs of visible wear or damage.

Check springs in Snap Links and Pop Pins for proper tension and alignment.

If the spring sticks or has lost its rigidity, replace it immediately.

#### 5. Anti-Skid Surfaces

Replace if they appear worn or become slippery.

#### 7. Warning Instruction Labels

Inspect and familiarize yourself with all safety warnings and other user information on decals. Replace decals if damaged, illegible, or removed.

## WARRANTY

---

We strive to offer the simplest and fastest resolution to all product related concerns. Our warranty service program gives its customers the option to return the product for repair, exchange or refund if the product is determined to be defective.

- All products are warranted to the original purchaser.
- Warranties apply and cover all defects in material and workmanship.  
Frame (excluding coating): Lifetime  
Rope, Sheaves, Bearings and Labor: One-Year
- Customer is responsible for the cost of shipment to ROPEFLEX. Company “ship to” address for product returns and service will be provided once the RMA has been issued. It will be at ROPEFLEX’s discretion to determine the party responsible for cost of shipment back to customer.
- Out-of-Warranty Products are repaired only with the customer’s prior approval.
- 15 Day 100% Satisfaction Guarantee includes full refund of purchase price, less shipping, handling and restocking fee equaling 15% of price during purchase. Email for more details. If you decide to return a ROPEFLEX product, simply email us within 15 days to ask for a return authorization number (RMA). Items must be returned in original condition and packaging and postmarked no later than 2 weeks after the date of return authorization.

If you have any questions regarding ROPEFLEX equipment or any instruction found in this document, please call 650.549.5888 for assistance.